



# THE WALL-MOUNT™ HEAT PUMPS - (60HZ)

**Models: W18H to W60H**  
**Heating Capacities: 16,000 to 54,000 BTUH**  
**Cooling Capacities: 16,400 to 54,000 BTUH**

**60Hz**

**GREEN REFRIGERANT**  
**R-410A**

The Bard Wall-Mount Heat Pump is a self-contained energy efficient heating and cooling system, which is designed to offer maximum indoor comfort at a minimal cost without using valuable indoor floor space or outside ground space. This unit is the ideal product for versatile applications such as: new construction, modular offices, school modernization, telecommunication structures, portable structures or correctional facilities. Factory or field installed accessories are available to meet specific job requirements.

## Engineered Features

### Aluminum Finned Copper Coils:

Grooved tubing and enhanced louvered fin for maximum heat transfer and energy efficiency.

### Twin Blowers:

Move air quietly. Most models feature multispeed blower motors providing airflow adjustment for high and low static operation. Motor overload protection is standard on all models.

### Heat Pump Compressor:

Scroll Compressors are standard on all 1½ to 5 ton models. Eliminates need for crankcase heater.

### Phase Rotation Monitor:

Standard on all 3 phase scroll compressors. Protects against reverse rotation if power supply is not properly connected.

### R-410A Refrigerant:

Designed with R-410A (HFC) non-ozone depleting refrigerant in compliance with the Montreal protocol and 2010 EPA requirements.

### Liquid Line Filter Drier:

Standard on all units. Protects system against moisture.

### Galvanized 20 Gauge Zinc Coated Steel Cabinet:

Cleaned, rinsed, sealed and dried before the polyurethane primer is applied. The cabinet is handsomely finished with a baked on, beige textured enamel, which allows it to withstand 1000 hours of salt spray tests per ASTM B117-03.

### Foil Faced Insulation:

Standard on all units.

### Electrical Components:

Are easily accessible for routine inspection and maintenance through a right side, service panel opening. Features a lockable, hinged access cover to the circuit breaker or toggle disconnect switch.

### Electric Heat Strips:

Features an automatic limit and thermal cut-off safety control. Heater packages are factory or field installed for all 1½ through 5 ton models. Features easy slide-in field assembly with various BTUH outputs.

### Condenser Fan and Motor

#### Shroud Assembly:

Slide out for easy access.

### Filter Service Door:

Separate service door provides easy access for filter change.

### One Inch, Disposable Air Filters:

Are standard equipment. Optional one inch washable filters available and filter racks permit the addition of 2" pleated filter. Factory or field installed.

### Solid State Electronic Heat Pump Control:

Provides efficient 30, 60 or 90 minute defrost cycle. A thermistor sensor, speed up terminal for service and 10 minute defrost override are standard on the electronic heat pump control.

### High & Low Pressure Switches are Auto-Reset:

Standard on all units. Built-in lockout circuit resets from the room thermostat. Provides commercial quality protection to the compressor.

### Five Minute Compressor Time Delay:

Short cycle protection is standard. Built into the heat pump control.

### Emergency Heat Circuit:

Permits continuous operation of the system.

### Barometric Fresh Air Damper:

Standard on all units. Allows up to 25% outside fresh air.

### Built-in Circuit Breakers:

Standard on all electric heat versions of single and three phase (230/208 volt) equipment. Toggle disconnects are standard on all electric heat versions of three phase (460 volt) equipment.

### Slope Top:

Standard feature for water run-off.

### Full Length Mounting Brackets:

Built into cabinet for improved appearance and easy installation. NOTE: Bottom mounting bracket included to assist in installation.

### Top Rain Flashing:

Standard feature on all models.



## Ventilation System Packages

All packages are designed to meet your specific ventilation requirements utilizing one of six ventilation options for the product. The ventilation package is mounted within the unit eliminating the need for an exterior mounted hood or damper assembly on the unit. All assemblies can be factory installed, installed in the field at time of installation or as a retrofit system after installation.

- Standard - Barometric Fresh Air Damper
- Optional - Motorized Fresh Air Damper
- Optional - Blank off Plate
- Optional - Commercial Room Ventilator w/Exhaust
  - CRV - Spring Return
  - CRVP - Power Return
- Optional - Economizer with Exhaust
- Optional - Energy Recovery Ventilator



- Complies with efficiency requirements of ASHRAE/IESNA 90.1-2007.
- Certified to ANSI/ARI Standard 390-2003 for SPVU (Single Package Vertical Units).
- Intertek ETL Listed to Standard for Safety Heating and Cooling Equipment ANSI/UL 1995/CSA 22.2 No. 236-05, Third Edition.
- Commercial Product - Not intended for Residential application.

## Capacity and Efficiency Ratings

MODELS	W18H1	W24H1	W30H1	W36H1	W42H1	W48H1	W60H1
Cooling BTUH ①	16,400	23,400	29,800	34,600	42,000	46,000	54,000
EER ②	9.50	9.00	9.20	9.00	9.00	9.00	9.00
High Temp Heating (47F) BTUH ①	16,000	24,000	29,000	35,000	42,000	44,000	54,000
COP ②	3.00	3.00	3.00	3.00	3.00	3.00	3.00
Low Temp Heating (17F) BTUH ①	9,000	14,000	17,000	21,000	25,000	26,000	32,000
COP ②	1.80	2.00	2.00	2.00	2.00	2.00	2.00

① Capacity is certified in accordance with ANSI/ARI Standard 390-2003.

② EER = Energy Efficiency Ratio, COP = Coefficient of Performance and are certified in accordance with ANSI/ARI Standard 390-2003.

## Specifications 1-1/2 through 3 Ton

MODELS	W18H1-A	W24H1-A	W24H1-B	W24H1-C	W30H1-A	W30H1-B	W30H1-C	W36H1-A	W36H1-B	W36H1-C
Electrical Rating--60HZ	230/208 - 1	230/208 - 1	230/208 - 3	460 - 3	230/208 - 1	230/208 - 3	460 - 3	230/208 - 1	230/208 - 3	460 - 3
Operating Voltage Range	197-253	197-253	197-253	414-506	197-253	197-253	414-506	197-253	197-253	414-506
<b>Compressor--Circuit A</b>										
Voltage	230/208	230/208	230/208	460	230/208	230/208	460	230/208	230/208	460
Rated Load Amps	6.2/7.3	12.7/15.2	8.3/9.9	6.1	12.4/13.6	8.0/8.7	5.5	14.7/16.4	10.9/12.1	5.5
Branch Circuit Selection Current	9.0	15.2	9.9	6.1	14.2	9.0	5.7	18.0	13.3	6.0
Lock Rotor Amps	48/48	67/64	58/58	28	77/77	71/71	38	112/112	88/88	44
Compressor Type	Scroll	Scroll	Scroll	Scroll	Scroll	Scroll	Scroll	Scroll	Scroll	Scroll
<b>Fan Motor &amp; Condenser</b>										
Fan Motor--HP-RPM	1/5 - 1075	1/5 - 1075	1/5 - 1075	1/5 - 1075	1/5 - 1075	1/5 - 1075	1/5 - 1075	1/5 - 1075	1/5 - 1075	1/5 - 1075
Fan Motor--Amps	1.2	1.2	1.2	1.4	1.5	1.5	1.4	1.5	1.5	1.4
Fan--DIA/CFM	18" - 1600	18" - 1600	18" - 1600	18" - 1600	20" - 2000	20" - 2000	20" - 2000	20" - 2000	20" - 2000	20" - 2000
<b>Motor &amp; Evaporator</b>										
Blower Motor--HP/RPM/SPD	1/6-1100-2	1/6-1100-1	1/6-1100-1	1/3-1100-2	1/3-1100-2	1/3-1100-2	1/3-1100-2	1/3-1100-2	1/3-1100-2	1/3-1100-2
Blower Motor--Amps	1.0	1.0	1.0	1.1	2.2	2.2	1.1	2.2	2.2	1.1
CFM Cooling & E.S.P. w/Filter (Rated - Wet Coil)	600 - .3	800 - .2	800 - .2	800 - .2	1000 - .4	1000 - .4	1000 - .4	1100 - .3	1100 - .3	1100 - .3
Filter Sizes (inches) STD.	16 x 25 x 1	16 x 25 x 1	16 x 25 x 1	16 x 25 x 1	16 x 30 x 1	16 x 30 x 1	16 x 30 x 1	16 x 30 x 1	16 x 30 x 1	16 x 30 x 1
<b>Shipping Weight --LBS.</b>	360	360	360	360	400	400	400	400	400	400

## Specifications 3-1/2 through 5 Ton

MODELS	W42H1-A	W42H1-B	W42H1-C	W48H1-A	W48H1-B	W48H1-C	W60H1-A	W60H1-B	W60H1-C
Electrical Rating--60HZ	230/208 - 1	230/208 - 3	460 - 3	230/208 - 1	230/208 - 3	460 - 3	230/208 - 1	230/208 - 3	460 - 3
Operating Voltage Range	197-253	197-253	414-506	197-253	197-253	414-506	197-253	197-253	414-506
<b>Compressor--Circuit A</b>									
Voltage	230/208	230/208	460	230/208	230/208	460	230/208	230/208	460
Rated Load Amps	18.4/21.5	11.6/13.5	6.1	19.5/21.2	13.6/14.7	6.6	21.5/25.3	12.8/15.1	7.6
Branch Circuit Selection Current	21.8	13.8	6.3	23.1	16.1	7.1	26.3	15.7	7.8
Lock Rotor Amps	117/117	84/84	41	131/131	91/91	46	134/134	110/110	52
Compressor Type	Scroll	Scroll	Scroll	Scroll	Scroll	Scroll	Scroll	Scroll	Scroll
<b>Fan Motor &amp; Condenser</b>									
Fan Motor--HP/RPM/SPD	1/3 - 825 - 2	1/3 - 825 - 2	1/3 - 825 - 2	1/3 - 825 - 2	1/3 - 825 - 2	1/3 - 825 - 2	1/3 - 825 - 2	1/3 - 825 - 2	1/3 - 825 - 2
Fan Motor--Amps	2.5	2.5	1.3	2.5	2.5	1.3	2.5	2.5	1.3
Fan--DIA/CFM	24" - 2750	24" - 2750	24" - 2750	24" - 2750	24" - 2750	24" - 2750	24" - 2750	24" - 2750	24" - 2750
<b>Motor &amp; Evaporator</b>									
Blower Motor--HP/RPM/SPD	1/2-1070-2	1/2-1070-2	1/2-1070-2	1/2-1070-2	1/2-1070-2	1/2-1070-2	1/2-1070-2	1/2-1070-2	1/2-1070-2
Blower Motor--Amps	3.3	3.3	1.9	3.3	3.3	1.9	3.3	3.3	1.9
CFM Cooling & E.S.P. w/Filter (Rated - Wet Coil)	1400 - .3	1400 - .3	1400 - .3	1550 - .2	1550 - .2	1550 - .2	1700 - .3	1700 - .3	1700 - .3
Filter Sizes (inches) STD.	20 x 30 x 1	20 x 30 x 1	20 x 30 x 1	20 x 30 x 1	20 x 30 x 1	20 x 30 x 1	20 x 30 x 1	20 x 30 x 1	20 x 30 x 1
<b>Shipping Weight --LBS.</b>	550	550	550	550	550	550	580	580	580

## Ventilation System Packages

Bard Wall-Mounts are designed to provide optional ventilation packages to meet all of your ventilation and indoor air quality requirements. All units are equipped with a barometric fresh air damper as the standard ventilation package. All ventilation packages can be built-in at the factory, or field-installed at a later date.



Barometric Fresh Air Damper

### BAROMETRIC FRESH AIR DAMPER - BFAD

**STANDARD**

The barometric fresh air damper is a standard feature on all models. It is installed on the inside of the service door and allows outside ventilation air, up to 25% of the total airflow rating of the unit, to be introduced through the air inlet openings and to be mixed with the conditioned air. The damper opens during blower operation and closes when the blower is off. Adjustable blade stops allow different amounts of outside air to be introduced into the building and can be easily locked closed if required.



Motorized Fresh Air Damper

### BLANK OFF PLATE - BOP

**OPTIONAL**

A blank off plate is installed on the inside of the service door. It covers the air inlet openings which restricts any outside air from entering into the unit. The blank off plate should be utilized in applications where outside air is not required to be mixed with the conditioned air.

### MOTORIZED FRESH AIR DAMPER - MFAD

**OPTIONAL**

The motorized fresh air damper is internally mounted behind the service door and allows outside ventilation air, up to 25% of the total airflow rating of the unit, to be introduced through the air inlet openings and to be mixed with the conditioned air. The two position damper can be fully open or closed. The damper blade is powered open by a 24VAC motor with spring return on power loss. The damper can be controlled by indoor blower operation or can be field connected to be managed based on building occupancy.

**NOTE:** The above vent systems are intake only without built-in exhaust capability. Building will likely require separate field installed barometric relief or mechanical exhaust elsewhere within the conditioned space. Balancing dampers in the return air grille may be required to achieve specified amount of outdoor air intake.



Commercial Room Ventilator

### COMMERCIAL ROOM VENTILATOR - CRV

**OPTIONAL**

The built-in commercial room ventilator is internally mounted behind the service door and allows outside ventilation air, up to 50% of the total airflow rating of the unit, to be introduced through the air inlet openings. It includes a built-in exhaust air damper.

The commercial room ventilator (CRV) is a simple and innovative approach to improving the indoor air quality by providing fresh air intake and exhaust capability through the CRV. The damper can be easily adjusted to control the amount of fresh air supplied into the building. The CRV can be controlled by indoor blower operation or field controlled based on room occupancy. Two versions available (except on 1.5 and 2-Ton models). The CRV and CRVS are power open - spring return on power loss, and CRVP is power open and power close. Complies with ANSI/ASHRAE Standard 62.1 "Ventilation for Acceptable Indoor Air Quality."



Economizer

### ECONOMIZER - EIFM

**OPTIONAL**

The built-in economizer system is internally mounted behind the service door and allows outdoor air to be introduced through the air inlet openings. The amount of outdoor air varies in response to the system controls and settings defined by the end user. It includes a built-in exhaust air damper. The economizer is designed to provide "free cooling" when outside air conditions are cool and dry enough to satisfy cooling requirements without running the compressor. This in turn provides lower operating costs, while extending the life of the compressor.

#### Standard Features:

- One Piece Construction - Easy to install with no mechanical linkage adjustment required.
- Exhaust Air Damper - Built in with positive closed position. Provides exhaust air capability to prevent pressurization of tight buildings.
- Actuator Motor - 24 volt, power open, spring return with built in torque limiting switch.
- Proportioning Type Control - for maximum "free cooling" economy and comfort.
- Moisture Eliminator & Prefilter - permanent, washable aluminum construction.
- Enthalpy Control - adjustable to monitor outdoor temperature and humidity.
- Minimum Position Potentiometer - adjustable to control minimum damper blade position for ventilation purposes.
- Mixed Air Sensor - to monitor outside and return air to automatically modulate damper position.



Energy Recovery Ventilator

### WALL-MOUNT ENERGY RECOVERY VENTILATOR - ERVF

**OPTIONAL**

The wall-mount energy recovery ventilator (ERV) is a highly innovative approach to meeting indoor air quality ventilation requirements as established by ANSI/ASHRAE Standard 62.1. The ERV allows from 200 to 450 CFM (depending upon model) of fresh air and exhaust through the unit while maintaining superior indoor comfort and humidity levels. In most cases this can be accomplished without increasing equipment sizing or operating costs. Heat transfer efficiency is up to 67% during summer and 75% during winter conditions.

The ERV consists of a unique "rotary energy recovery cassette" that provides effective sensible and latent heat transfer capabilities during summer and winter conditions. Various control schemes are addressed including limiting ventilation during building occupancy only.

The ERV is designed to be internally mounted behind the service door in the W\*\*A, W\*\*H or W\*\*L model wall-mount units. It can be built-in at the factory or field installed as an option. ERVF-\*3 and ERVF-\*5 can be independently adjusted for intake and exhaust rates.

Manufactured under U.S. Patent Nos. 5,485,878; 5,301,744; 5,002,116.

## Commercial Room Ventilator Performance Data - CRV-2

### W18 & W24 TOTAL AND VENTILATION AIRFLOW

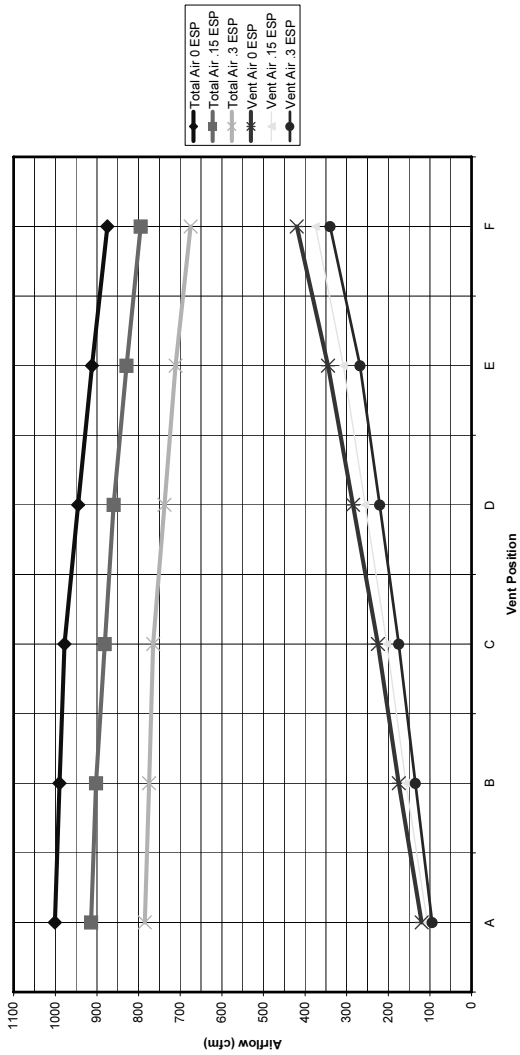

## Commercial Room Ventilator Performance Data - CRVS-3 and CRVP-3

### W30 & W36 HIGH SPEED TOTAL AND VENTILATION AIRFLOW

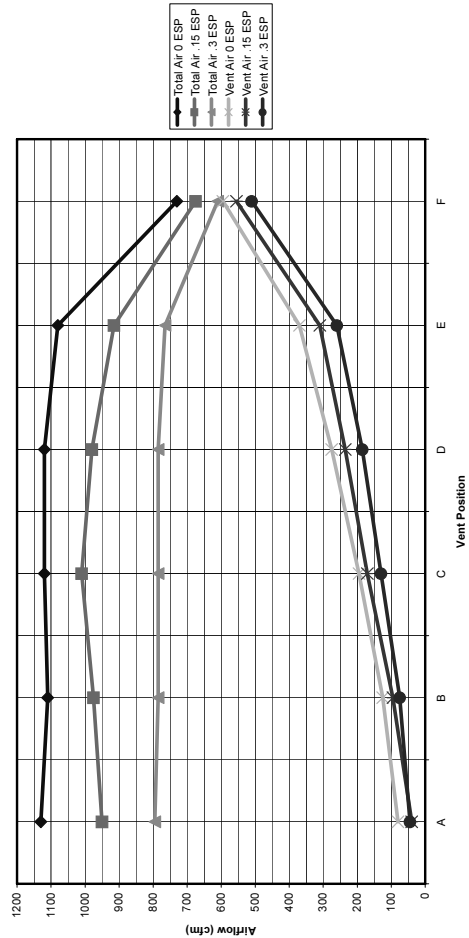

### W30 & W36 LOW SPEED TOTAL AND VENTILATION AIRFLOW

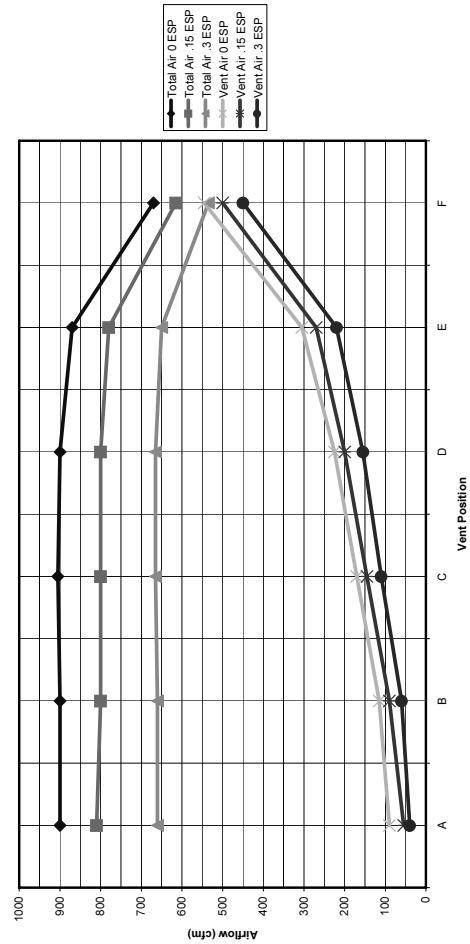

Commercial Room Ventilator Performance Data - CRVS-5 and CRVP-5

W42 & W48 HIGH SPEED TOTAL AND VENTILATION AIRFLOW

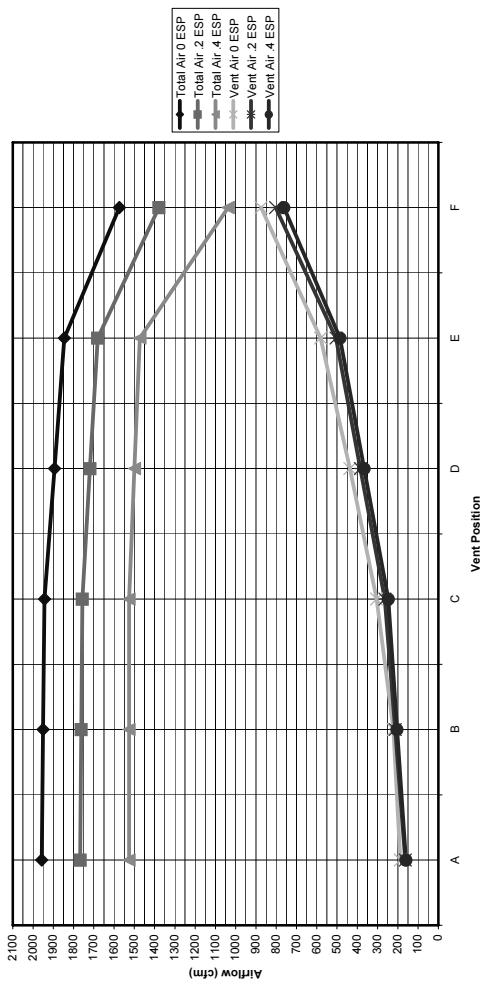

W60 HIGH SPEED TOTAL AND VENTILATION AIRFLOW

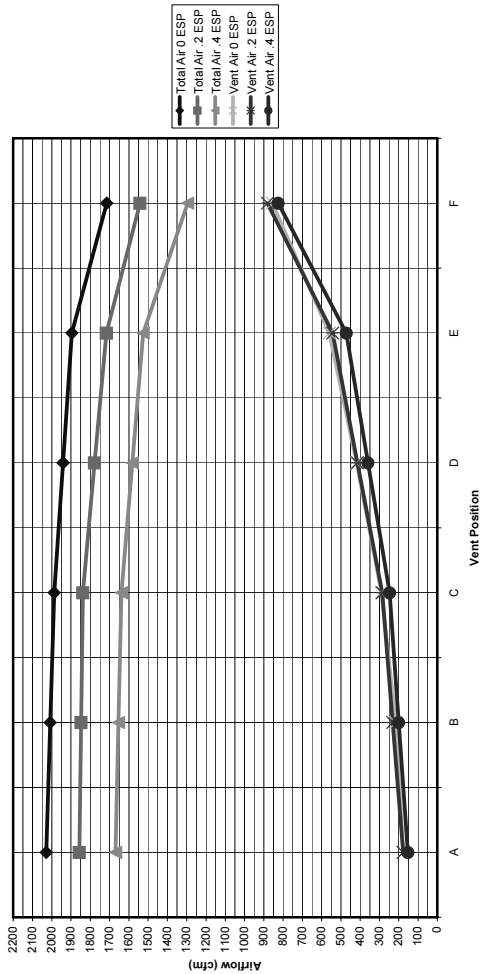

W42 & W48 LOW SPEED TOTAL AND VENTILATION AIRFLOW

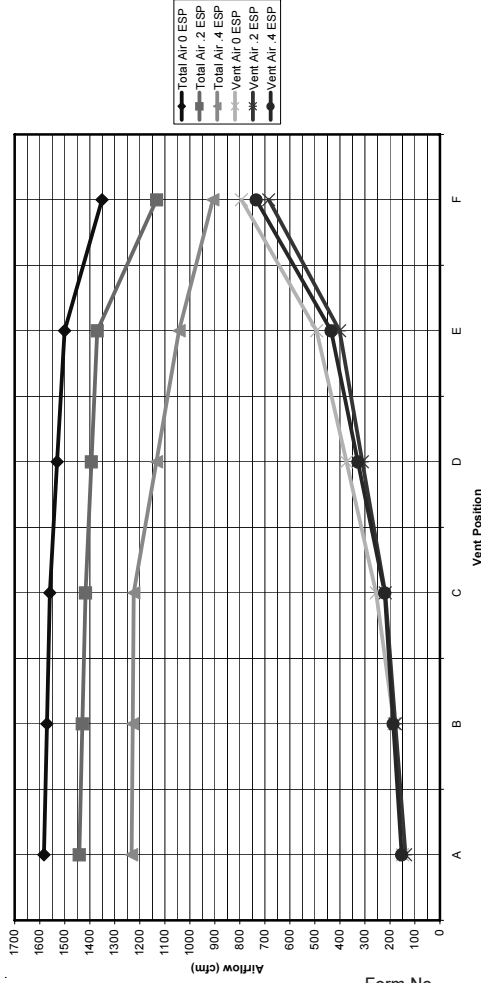

W60 LOW SPEED TOTAL AND VENTILATION AIRFLOW

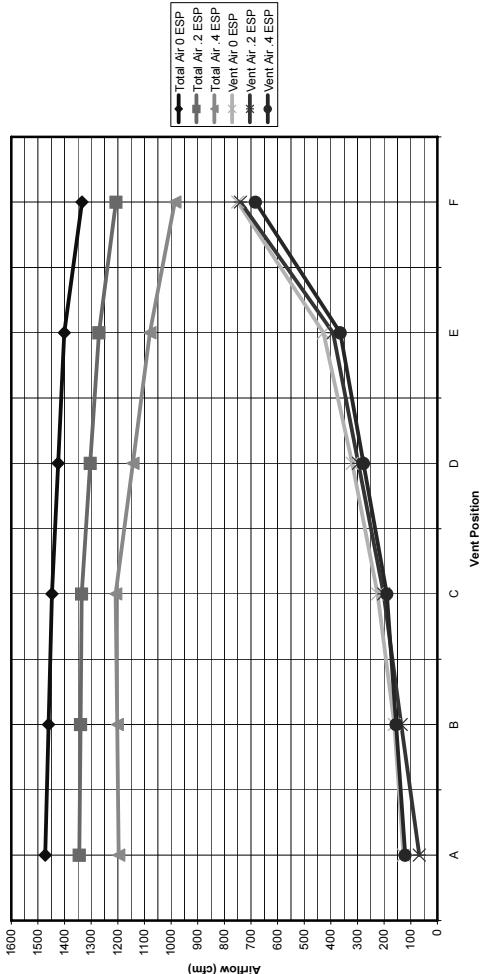

# Performance and Application Data- ERVF-\*2B

## SUMMER COOLING PERFORMANCE (INDOOR DESIGN CONDITIONS 75°DB/62°WB)

Ambient O.D.	VENTILATION RATE -- 250 CFM 62% EFFICIENCY							VENTILATION RATE -- 225 CFM 63% EFFICIENCY							VENTILATION RATE -- 200 CFM 63% EFFICIENCY						
	DB/ WB	F	VLT	VLS	VLL	HRT	HRS	HRL	VLT	VLS	VLL	HRT	HRS	HRL	VLT	VLS	VLL	HRT	HRS	HRL	
105	75	11925	8100	1325	7394	5022	822	10727	7287	3441	6758	4591	2168	9540	6480	3060	6010	4082	1928		
	70	8100	8100	0	5022	5022	0	7287	7287	0	4591	4591	0	6480	6480	0	4082	4082	0		
	65	8100	8100	0	5022	5022	0	7287	7287	0	4591	4591	0	6480	6480	0	4082	4082	0		
100	80	17550	6750	10800	10881	4185	6696	15788	6072	9716	9946	3826	6121	14040	5400	8640	8845	3402	5443		
	75	11925	6750	5175	7394	4185	3209	10727	6072	4655	6758	3826	2933	9540	5400	4140	6010	3402	2608		
	70	6863	6750	113	4255	4185	70	6173	6072	101	3889	3826	64	5490	5400	90	3458	3402	56		
	65	6750	6750	0	4185	4185	0	6072	6072	0	3826	3826	0	5400	5400	0	3402	3402	0		
	60	6750	6750	0	4185	4185	0	6072	6072	0	3826	3826	0	5400	5400	0	3402	3402	0		
95	80	17550	5400	12150	10881	3348	7533	15788	4858	10930	9946	3060	6886	14040	4320	9720	8845	2722	6124		
	75	11925	5400	6525	7394	3348	4046	10727	4858	5870	6758	3060	3698	9540	4320	5220	6010	2722	3289		
	70	6863	5400	1463	4255	3348	907	6173	4858	1315	3889	3060	829	5490	4320	1170	3458	2722	737		
	65	5400	5400	0	3348	3348	0	4858	4858	0	3060	3060	0	4320	4320	0	2722	2722	0		
	60	5400	5400	0	3348	3348	0	4858	4858	0	3060	3060	0	4320	4320	0	2722	2722	0		
90	80	17550	4050	13500	10881	2511	8370	15788	3643	12145	9946	2295	7651	14040	3240	10800	8845	2041	6804		
	75	11925	4050	7875	7394	2511	4883	10727	3643	7084	6758	2295	4463	9540	3240	6300	6010	2041	3969		
	70	6863	4050	2813	4255	2511	1744	6173	3643	2530	3889	2295	1594	5490	3240	2250	3458	2041	1417		
	65	4050	4050	0	2511	2511	0	3643	3643	0	2295	2295	0	3240	3240	0	2041	2041	0		
	60	4050	4050	0	2511	2511	0	3643	3643	0	2295	2295	0	3240	3240	0	2041	2041	0		
85	80	17550	2700	14850	10881	1674	9207	15788	2429	13359	9946	1530	8416	14040	2160	11880	8845	1361	7484		
	75	11925	2700	9225	7394	1674	5720	10727	2429	8298	6758	1530	5228	9540	2160	7380	6010	1361	4649		
	70	6863	2700	4163	4255	1674	2581	6173	2429	3744	3889	1530	2359	5490	2160	3300	3458	1361	2098		
	65	2700	2700	0	1674	1674	0	2429	2429	0	1530	1530	0	2160	2160	0	1361	1361	0		
	60	2700	2700	0	1674	1674	0	2429	2429	0	1530	1530	0	2160	2160	0	1361	1361	0		
80	75	11925	1350	10575	7394	837	6557	10727	1214	9513	6758	765	5993	9540	1080	8460	6010	680	5330		
	70	6863	1350	5513	4255	837	3418	6173	1214	4959	3889	765	3124	5490	1080	4410	3458	680	2778		
	65	2363	1350	1013	1465	837	628	2125	1214	911	1339	765	547	1890	1080	810	1190	680	510		
	60	1350	1350	0	837	837	0	1214	1214	0	765	765	0	1080	1080	0	680	680	0		
75	70	6863	0	6863	4255	0	4255	6173	0	6173	6889	0	3889	5490	0	5490	3458	0	3458		
	65	2363	0	2363	1465	0	1465	2125	0	2125	1339	0	1339	1890	0	1890	1190	0	1190		
	60	0	0	0	0	0	0	0	0	0	0	0	0	0	0	0	0	0	0		

## ERVF-A2 WINTER HEATING PERFORMANCE (INDOOR DESIGN CONDITIONS 70°F DB)

Ambient O.D.	VENTILATION RATE					
	250 CFM 74% EFF.		225 CFM 75% EFF.		200 CFM 75% EFF.	
DB/°F	WVL	WHR	WVL	WHR	WVL	WHR
65	1350	999	1214	911	1080	810
60	2700	1998	2429	1822	2160	1620
55	4050	2997	3643	2733	3240	2430
50	5400	3996	4858	3643	4320	3240
45	6750	4995	6072	4554	5400	4050
40	8100	5994	7287	5465	6480	4860
35	9450	6993	8501	6376	7560	5670
30	10800	7992	9716	7287	8640	6480
25	12150	8991	10930	8198	9720	7290
20	13500	9990	12145	9108	10800	8100
15	14850	10989	13359	10019	11880	8910

LEGEND:

- VLT = Ventilation Load - Total
- VLS = Ventilation Load - Sensible
- VLL = Ventilation Load - Latent
- HRT = Heat Recovery - Total
- HRS = Heat Recovery - Sensible
- HRL = Heat Recovery - Latent
- WVL = Winter Ventilation Load
- WHR = Winter Heat Recovery

NOTE: Sensible performance only is shown for winter application.

# Performance and Application Data- ERVF-\*3C

## SUMMER COOLING PERFORMANCE (INDOOR DESIGN CONDITIONS 75°DB/62°WB)

Ambient O.D.		VENTILATION RATE -- 400CFM 63% EFFICIENCY						VENTILATION RATE -- 325 CFM 64% EFFICIENCY						VENTILATION RATE -- 250 CFM 65% EFFICIENCY					
DB/ WB	F	VLT	VLS	VLL	HRT	HRS	HRL	VLT	VLS	VLL	HRT	HRS	HRL	VLT	VLS	VLL	HRT	HRS	HRL
105	75	19080	12960	6120	12020	8164	3855	15502	10530	4972	9921	6739	3182	11925	8100	3825	7751	5265	2486
	70	12960	12960	0	8164	8164	0	10530	10530	0	6739	6739	0	8100	8100	0	5265	5265	0
	65	12960	12960	0	8164	8164	0	10530	10530	0	6739	6739	0	8100	8100	0	5265	5265	0
100	80	28080	10800	17280	17690	6804	10886	22815	8775	14040	14601	5616	8985	17550	6750	10800	11407	4387	7019
	75	19080	10800	8280	12020	6804	5216	15502	8775	6727	9921	5616	4305	11925	6750	5175	7751	4387	3363
	70	10980	10800	180	6717	6804	113	8921	8775	146	5709	5616	93	6862	6750	112	4460	4387	73
	65	10800	10800	0	6804	6804	0	8775	8775	0	5616	5616	0	6750	6750	0	4387	4387	0
	60	10800	10800	0	6804	6804	0	8775	8775	0	5616	5616	0	6750	6750	0	4387	4387	0
95	80	28080	8640	19440	17690	5443	12247	22815	7020	15795	14601	4492	10108	17550	5400	12150	11407	3510	7897
	75	19080	8640	10440	12020	5443	6577	15502	7020	8482	9921	4492	5428	11925	5400	6525	7751	3510	4241
	70	10980	8640	2340	6917	5443	1474	8921	7020	1901	5709	4492	1216	6862	5400	1462	4460	3510	950
	65	8640	8640	0	5443	5443	0	7020	7020	0	4492	4492	0	5400	5400	0	3510	3510	0
	60	8640	8640	0	5443	5443	0	7020	7020	0	4492	4492	0	5400	5400	0	3510	3510	0
90	80	28080	6480	21600	17690	4082	13608	22815	5265	17550	14601	3369	11232	17550	4050	13500	11407	2632	8774
	75	19080	6480	12600	12020	4082	7938	15502	5265	10237	9921	3369	6552	11925	4050	7875	7751	2632	5118
	70	10980	6480	4500	6917	4082	2835	8921	5265	3656	5709	3369	2340	6862	4050	2812	4460	2632	1828
	65	6480	6480	0	4082	4082	0	5265	5265	0	3369	3369	0	4050	4050	0	2632	2632	0
	60	6480	6480	0	4082	4082	0	5265	5265	0	3369	3369	0	4050	4050	0	2632	2632	0
85	80	28080	4320	23760	17690	2721	14968	22815	3510	19305	14601	2246	12355	17550	2700	14850	11407	1755	9652
	75	19080	4320	14760	12020	2721	9298	15502	3510	11992	9921	2246	7675	11925	2700	9225	7751	1755	5996
	70	10980	4320	6660	6917	2721	4195	8921	3510	5411	5709	2246	3463	6862	2700	4162	4460	1755	2705
	65	4320	4320	0	2721	2721	0	3510	3510	0	2246	2246	0	2700	2700	0	1755	1755	0
	60	4320	4320	0	2721	2721	0	3510	3510	0	2246	2246	0	2700	2700	0	1755	1755	0
80	75	19080	2160	16920	12020	1360	10659	15502	1755	13747	9921	1123	8798	11925	1350	10575	7751	877	6873
	70	10980	2160	8820	6917	1360	5556	8921	1755	7166	5709	1123	4586	6862	1350	5512	4460	877	3583
	65	3780	2160	1620	2381	1360	1020	3071	1755	1316	1965	1123	842	2362	1350	1012	1535	877	658
	60	2160	2160	0	1360	1360	0	1755	1755	0	1123	1123	0	1350	1350	0	877	877	0
75	70	10980	0	10980	6917	0	6917	8921	0	8921	5709	0	5709	6862	0	6862	4460	0	4460
	65	3780	0	3780	2381	0	2380	3071	0	3071	1965	0	1965	2362	0	2362	1535	0	1535
	60	0	0	0	0	0	0	0	0	0	0	0	0	0	0	0	0	0	0

## ERVF-\*3 WINTER HEATING PERFORMANCE (INDOOR DESIGN CONDITIONS 70°F DB)

Ambient O.D.	VENTILATION RATE					
	400 CFM 75% EFFICIENCY		325 CFM 76% EFFICIENCY		250 CFM 77% EFFICIENCY	
DB/°F	WVL	WHR	WVL	WHR	WVL	WHR
65	2160	1620	1755	1333	1350	1039
60	4320	3240	3510	2667	2700	2079
55	6480	4860	5265	4001	4050	3118
50	8640	6480	7020	5335	5400	4158
45	10800	8100	8775	6669	6750	5197
40	12960	9720	10530	8002	8100	6237
35	15120	11340	12285	9336	9450	7276
30	17280	12960	14040	10670	10800	8316
25	19440	14580	15795	12004	12150	9355
20	21600	16200	17550	13338	13500	10395
15	23760	17820	19305	14671	14850	11434

### LEGEND:

VLT = Ventilation Load - Total  
VLS = Ventilation Load - Sensible  
VLL = Ventilation Load - Latent  
HRT = Heat Recovery - Total  
HRS = Heat Recovery - Sensible  
HRL = Heat Recovery - Latent  
WVL = Winter Ventilation Load  
WHR = Winter Heat Recovery

NOTE: Sensible performance only is shown for winter application.

# Performance and Application Data- ERVF-\*5C

## SUMMER COOLING PERFORMANCE (INDOOR DESIGN CONDITIONS 75°DB/62°WB)

Ambient O.D.	VENTILATION RATE 450 CFM 65% EFFICIENCY						VENTILATION RATE 375 CFM 66% EFFICIENCY						VENTILATION RATE 300 CFM 67% EFFICIENCY							
	DB/ WB	F	VLT	VLS	VLL	HRT	HRS	HRL	VLT	VLS	VLL	HRT	HRS	HRL	VLT	VLS	VLL	HRT	HRS	HRL
105	75		21465	14580	6884	13952	9477	4475	17887	12150	5737	11805	8018	3786	14310	9720	4590	9587	6512	3075
	70		14580	14580	0	9477	9477	0	12150	12150	0	8018	8018	0	9720	9720	0	6512	6512	0
	65		14580	14580	0	9477	9477	0	12150	12150	0	8018	8018	0	9720	9720	0	6512	6512	0
100	80		31590	12150	19440	20533	7897	12635	26325	10125	16200	17374	6682	10692	21060	8100	12960	14110	5427	8683
	75		21465	12150	9314	13952	7897	6054	17887	10125	7762	11805	6682	5123	14310	8100	6210	9587	5427	4160
	70		12352	12150	202	8029	7897	131	10293	10125	168	6793	6682	111	8235	8100	135	5517	5427	90
	65		12150	12150	0	7897	7897	0	10125	10125	0	6682	6682	0	8100	8100	0	5427	5427	0
	60		12150	12150	0	7897	7897	0	10125	10125	0	6682	6682	0	8100	8100	0	5427	5427	0
95	80		31590	9720	21870	20533	6318	14215	26325	8100	18225	17374	5345	12028	21060	6480	14580	14110	4341	9768
	75		21465	9720	11744	13952	6318	7634	17887	8100	9787	11805	5345	6459	14310	6480	7830	9587	4341	5246
	70		12352	9720	2632	8029	6318	1711	10293	8100	2193	6793	5345	1447	8235	6480	1755	5517	4341	1175
	65		9720	9720	0	6318	6318	0	8100	8100	0	5345	5345	0	6480	6480	0	4341	4341	0
	60		9720	9720	0	6318	6318	0	8100	8100	0	5345	5345	0	6480	6480	0	4341	4341	0
90	80		31590	7290	24300	20533	4738	15794	26325	6075	20250	17374	4009	13365	21060	4860	16200	14110	3256	10854
	75		21465	7290	14175	13952	4738	9213	17887	6075	11812	11805	4009	7796	14310	4860	9450	9587	3256	6331
	70		12352	7290	5062	8029	4738	3290	10293	6075	4218	6793	4009	2784	8235	4860	3375	5517	3256	2261
	65		7290	7290	0	4738	4738	0	6075	6075	0	4009	4009	0	4860	4860	0	3256	3256	0
	60		7290	7290	0	4738	4738	0	6075	6075	0	4009	4009	0	4860	4860	0	3256	3256	0
85	80		31590	4860	26730	20533	3159	17374	26325	4050	22275	17374	2672	14701	21060	3240	17820	14110	2170	11939
	75		21465	4860	16605	13952	3159	10793	17887	4050	13837	11805	2672	9132	14310	3240	11070	9587	2170	7416
	70		12352	4860	7492	8029	3159	4870	10293	4050	6243	6793	2672	4120	8235	3240	4995	5517	2170	3346
	65		4860	4860	0	3159	3159	0	4050	4050	0	2672	2672	0	3240	3240	0	2170	2170	0
	60		4860	4860	0	3159	3159	0	4050	4050	0	2672	2672	0	3240	3240	0	2170	2170	0
80	75		21465	2430	19035	13952	1579	12372	17887	2025	15862	11805	1336	10469	14310	1620	12690	9587	1085	8502
	70		12352	2430	9922	8029	1579	6449	10293	2025	8268	6793	1336	5457	8235	1620	6615	5517	1085	4432
	65		4252	2430	1822	2764	1579	1184	3543	2025	1518	2338	1336	1002	2835	1620	1215	1899	1085	814
	60		2430	2430	0	1579	1579	0	2025	2025	0	1336	1336	0	1620	1620	0	1085	1085	0
75	70		12352	0	12352	8029	0	8029	10293	0	10293	6793	0	6793	8235	0	8235	5517	0	5517
	65		4252	0	4252	2764	0	2764	3543	0	3543	2338	0	2338	2835	0	2835	1899	0	1899
	60		0	0	0	0	0	0	0	0	0	0	0	0	0	0	0	0	0	0

## ERVF-\*5 WINTER HEATING PERFORMANCE (INDOOR DESIGN CONDITIONS 70°F DB)

Ambient O.D.	VENTILATION RATE					
	450 CFM 80% EFFICIENCY		375 CFM 81% EFFICIENCY		300 CFM 82% EFFICIENCY	
DB/°F	WVL	WHR	WVL	WHR	WVL	WHR
65	2430	1944	2025	1640	1620	1328
60	4860	3888	4050	3280	3240	2656
55	7290	5832	6075	4920	4860	3985
50	9720	7776	8100	6561	6480	5313
45	12150	9720	10125	8201	8100	6642
40	14580	11664	12150	9841	9720	7970
35	17010	13608	14175	11481	11340	9298
30	19440	15552	16200	13122	12960	10627
25	21870	17496	18225	14762	14580	11955
20	24300	19440	20250	16402	16200	13284
15	26730	21384	22275	18042	17820	14612

### LEGEND:

VLT = Ventilation Load - Total  
VLS = Ventilation Load - Sensible  
VLL = Ventilation Load - Latent  
HRT = Heat Recovery - Total  
HRS = Heat Recovery - Sensible  
HRL = Heat Recovery - Latent  
WVL = Winter Ventilation Load  
WHR = Winter Heat Recovery

NOTE: Sensible performance only is shown for winter application.



### Clearances Required for Service Access and Adequate Condenser Airflow

MODELS	LEFT SIDE	RIGHT SIDE
W18H1, W24H1, W30H1, W36H1	15"	20"
W42H1, W48H1, W60H1	20"	20"

### Minimum Clearances Required to Combustible Materials

MODELS ①	SUPPLY AIR DUCT FIRST THREE FEET	CABINET
W18H1, W24H1	0"	0"
W30H1, W36H1	1/4"	0"
W42H1, W48H1, W60H1	1/4"	0"

① Refer to the Installation Manual for more detailed information.

### Dimensions of Basic Unit for Architectural and Installation Requirements (Nominal)

MODEL	WIDTH (W)	DEPTH (D)	HEIGHT (H)	SUPPLY		RETURN																
				A	B	C	D	E	F	G	I	J	K	L	M	N	O	P	Q	R	S	T
W18H1 W24H1	33.300	17.125	70.563	7.88	19.88	11.88	19.88	35.00	10.88	25.75	20.56	26.75	28.06	29.25	27.00	2.63	34.13	22.06	10.55	5.00	12.00	5.00
W30H1 W36H1	38.200	17.125	70.563	7.88	27.88	13.88	27.88	40.00	10.88	25.75	17.93	26.75	28.75	29.25	27.00	2.63	39.13	22.75	9.14	5.00	12.00	5.00
W42H1 W48H1	42.075	22.432	84.875	9.88	29.88	15.88	29.88	43.88	13.56	31.66	30.00	32.68	26.94	34.69	32.43	3.37	43.00	23.88	10.00	1.44	16.00	1.88
W60H1	42.075	22.432	94.875	9.88	29.88	15.88	29.88	43.88	13.56	41.66	30.00	42.68	36.94	44.69	42.43	3.37	43.00	33.88	10.00	1.44	16.00	1.88

All dimensions are in inches. Dimensional drawings are not to scale.

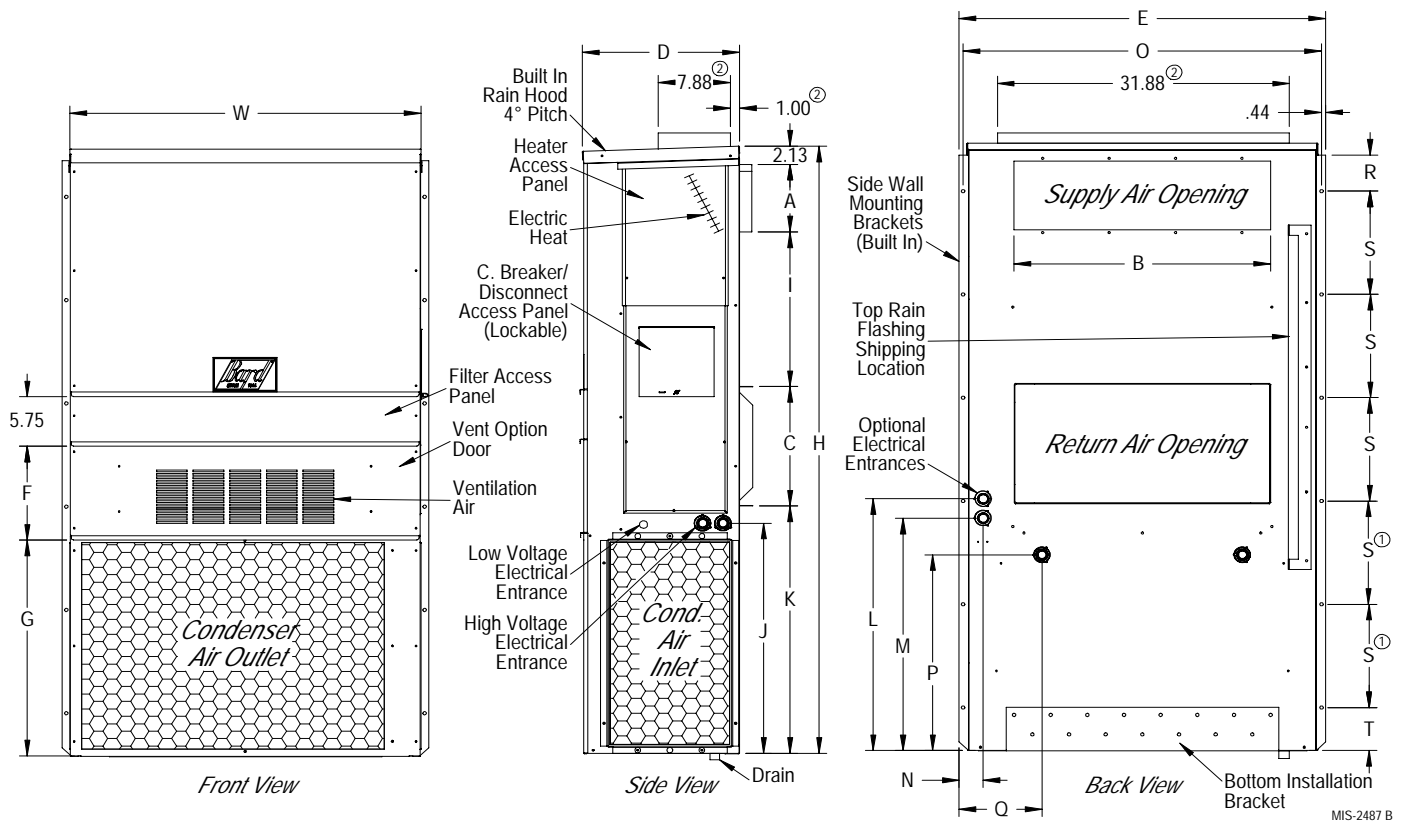

① 21.00" for model W60H1.

② Top supply opening is optional and available factory-built only on models W30H1 and W36H1.

## Electrical Specifications — Standard Heat Pumps

Model	Rated Volts and Phase	No. Field Power Circuits	Single Circuit				Dual Circuit							
			① Minimum Circuit Ampacity	② Maximum External Fuse or Ckt. Brkr.	③ Field Power Wire Size	④ Ground Wire	① Minimum Circuit Ampacity		② Maximum External Fuse or Ckt. Breaker		③ Field Power Wire Size		④ Ground Wire Size	
							Ckt. A	Ckt. B	Ckt. A	Ckt. B	Ckt. A	Ckt. B	Ckt. A	Ckt. B
W18H1- A00, A0Z A04 A08	230/208-1	1	16	20	12	12								
		1	37	40	8	10								
		1	58	60	6	10								
W24H1- A00, A0Z A04 A08	230/208-1	1	24	25	10	10								
		1	44	50	8	10								
		1 or 2	65	70	6	8	44	21	45	25	8	10	10	10
W24H1- B00, B0Z B06	230/208-3	1	17	20	12	12								
		1	35	40	8	10								
W24H1- C00, C0Z C06	460-3	1	11	15	14	14								
		1	21	25	10	10								
W30H1- A00, A0Z* A05* A10*	230/208-1	1	24	35	8	10								
		1	50	50	8	10								
		1 or 2	76	80	4	8	50	26	50	30	8	10	10	10
W30H1- B00, B0Z* B06 B09*	230/208-3	1	18	25	10	10								
		1	36	40	8	10								
		1	45	45	8	10								
W30H1- C00, C0Z* C06 C09* ③ C15	460-3	1	11	15	14	14								
		1	20	20	12	12								
		1	25	25	10	10								
		1	26	30	10	10								
W36H1- A00, A0Z* A05 A10* A15	230/208-1	1	29	40	8	10								
		1	55	60	6	10								
		1 or 2	81	90	4	8	55	26	60	30	6	10	10	10
		1 or 2	84	90	4	8	55	52	60	60	6	6	10	10
W36H1- B00, B0Z* B06 B09* ③ B15	230/208-3	1	23	30	10	10								
		1	41	45	8	10								
		1	50	50	8	10								
		1	51	60	8	10								
W36H1- C00, C0Z* C06 C09* ③ C15	460-3	1	12	15	14	14								
		1	21	25	10	10								
		1	25	25	10	10								
		1	26	30	10	10								
W42H1- A00, A0Z A04 A05 A10 ④ A15	230/208-1	1	36	50	8	10								
		1	57	60	6	10								
		1 or 2	62	70	6	8	36	26	50	30	8	10	10	10
		1 or 2	88	90	3	8	36	52	50	60	8	6	10	10
		1 or 2	88	90	3	8	36	52	50	60	8	6	10	10
W42H1- B00, B0Z B06 B09 ③ B15	230/208-3	1	26	35	8	10								
		1	44	50	8	10								
		1	53	60	6	10								
		1	53	60	6	10								
W42H1- C00, C0Z C06 C09 ③ C15	460-3	1	13	15	14	14								
		1	22	25	10	10								
		1	26	30	10	10								
		1	26	30	10	10								
W48H1- A00, A0Z A04 A05 A10 ④ A15 ④ A20	230/208-1	1	37	50	8	10								
		1	58	60	6	10								
		1 or 2	63	70	6	8	37	26	50	30	8	10	10	10
		1 or 2	89	90	3	8	37	52	50	60	8	6	10	10
		1 or 2	89	90	3	8	37	52	50	60	8	6	10	10
		1 or 2	111	125	2	6	59	52	60	60	6	6	10	10
W48H1- B00, B0Z B06 B09 ③ B15 ③ B18	230/208-3	1	29	35	8	10								
		1	47	50	8	10								
		1	56	60	6	10								
		1	56	60	6	10								
		2	N/A	N/A	N/A	N/A	34	28	40	30	8	10	10	10
W48H1- C00, C0Z C09 ③ C15	460-3	1	14	20	12	12								
		1	27	30	10	10								
		1	27	30	10	10								
W60H1- A00, A0Z A05 A10 ④ A15 ④ A20	230/208-1	1	41	60	8	10								
		1 or 2	67	80	4	8	41	26	60	30	8	10	10	10
		1 or 2	93	100	3	8	41	52	60	60	8	6	10	10
		1 or 2	93	100	3	8	41	52	60	60	8	6	10	10
		1 or 2	111	125	2	6	59	52	60	60	6	6	10	10
W60H1- B00, B0Z B09 ③ B15 ③ B18	230/208-3	1	28	40	8	10								
		1	55	60	6	10								
		1	55	60	6	10								
		2	N/A	N/A	N/A	N/A	34	28	40	30	8	10	10	10
W60H1- C00, C0Z C09 ③ C15	460-3	1	15	20	12	12								
		1	28	30	10	10								
		1	28	30	10	10								

① These "Minimum Circuit Ampacity" values are to be used for sizing the field power conductors. Refer to the National Electrical Code (latest version), Article 310 for power conductor sizing.  
**CAUTION:** When more than one field power circuit is run through one conduit, the conductors must be derated. Pay special attention to note 8 of Table 310 regarding Ampacity Adjustment Factors when more than three (3) conductors are in a raceway.

- ② Maximum size of the time delay fuse or HACR type circuit breaker for protection of field wiring conductors.
- ③ Maximum KW that can operate with the heat pump on is 9KW. Full heat available during emergency heat mode.
- ④ Maximum KW that can operate with the heat pump on is 10KW. Full heat available during emergency heat mode.

\* Available factory-built only with top outlet supply as an option.

**IMPORTANT:** While this electrical data is presented as a guide, it is important to electrically connect properly sized fuses & conductor wires in accordance with the National Electrical Code & all local codes.

## Electrical Specifications — Dehumidification Models

Model	SINGLE CIRCUIT						DUAL CIRCUIT							
	Rated Volts & Phase	No. Field Power Ckts.	①	②	③	③	①		②		③		③	
			Minimum Circuit Ampacity	Maximum External Fuse or Circuit Breaker	Field Power Wire Size	Ground Wire Size	Minimum Circuit Ampacity		Maximum External Fuse or Ckt. Breaker		Field Power Wire Size		Ground Wire Size	
			Ckt A	Ckt B	Ckt A	Ckt B	Ckt A	Ckt B	Ckt A	Ckt B	Ckt A	Ckt B		
W24H1DA00, A0Z A04 A08	230/208-1	1 1 1 or 2	24 44 65	30 50 70	10 8 6	10 10 8	N/A N/A 44	N/A N/A 21	N/A N/A 45	N/A N/A 25	N/A N/A 8	N/A N/A 10	N/A N/A 10	N/A N/A 10
W24H1DB00, B0Z B06	230/208-3	1 1	17 35	20 40	12 8	12 10	N/A N/A	N/A N/A	N/A N/A	N/A N/A	N/A N/A	N/A N/A	N/A N/A	N/A N/A
W24H1DC00, C0Z C06	460-3	1 1	12 21	15 25	14 10	14 10	N/A N/A	N/A N/A	N/A N/A	N/A N/A	N/A N/A	N/A N/A	N/A N/A	N/A N/A
W30H1DA00, A0Z A05 A10	230/208-1	1 1 1 or 2	27 52 79	35 60 80	8 6 4	10 10 8	N/A N/A 52	N/A N/A 26	N/A N/A 60	N/A N/A 30	N/A N/A 6	N/A N/A 10	N/A N/A 10	N/A N/A 10
W30H1DB00, B0Z B06 B09	230/208-3	1 1 1	19 37 47	25 40 50	10 8 8	10 10 10	N/A N/A N/A	N/A N/A N/A	N/A N/A N/A	N/A N/A N/A	N/A N/A N/A	N/A N/A N/A	N/A N/A N/A	N/A N/A N/A
W30H1DC00, C0Z C06 C09	460-3	1 1 1	12 21 26	15 25 30	14 10 10	14 10 10	N/A N/A N/A	N/A N/A N/A	N/A N/A N/A	N/A N/A N/A	N/A N/A N/A	N/A N/A N/A	N/A N/A N/A	N/A N/A N/A
W36H1DA00, A0Z A05 A10	230/208-1	1 1 1 or 2	30 56 82	40 60 90	10 6 4	10 10 8	N/A N/A 55	N/A N/A 26	N/A N/A 60	N/A N/A 30	N/A N/A 6	N/A N/A 10	N/A N/A 10	N/A N/A 10
W36H1DB00, B0Z B06 B09	230/208-3	1 1 1	24 42 51	30 50 60	10 8 6	10 10 10	N/A N/A N/A	N/A N/A N/A	N/A N/A N/A	N/A N/A N/A	N/A N/A N/A	N/A N/A N/A	N/A N/A N/A	N/A N/A N/A
W36H1DC00, C0Z C06 C09	460-3	1 1 1	12 21 25	15 25 25	14 10 10	14 10 10	N/A N/A N/A	N/A N/A N/A	N/A N/A N/A	N/A N/A N/A	N/A N/A N/A	N/A N/A N/A	N/A N/A N/A	N/A N/A N/A
W42H1DA00, A0Z A05 A10	230/208-1	1 1 or 2 1 or 2	40 66 92	60 70 100	8 6 3	10 8 8	N/A 40 40	N/A 26 52	N/A 50 50	N/A 30 60	N/A 8 8	N/A 10 6	N/A 10 10	N/A 10 10
W42H1DB00, B0Z B06 B09	230/208-3	1 1 1	28 46 55	40 50 60	8 8 6	10 10 10	N/A N/A N/A	N/A N/A N/A	N/A N/A N/A	N/A N/A N/A	N/A N/A N/A	N/A N/A N/A	N/A N/A N/A	N/A N/A N/A
W42H1DC00, C0Z C06 C09	460-3	1 1 1	14 23 27	20 25 30	12 10 10	12 10 10	N/A N/A N/A	N/A N/A N/A	N/A N/A N/A	N/A N/A N/A	N/A N/A N/A	N/A N/A N/A	N/A N/A N/A	N/A N/A N/A
W48H1DA00, A0Z A05 A10	230/208-1	1 1 or 2 1 or 2	38 64 90	50 80 90	8 6 3	10 8 8	N/A 38 38	N/A 26 52	N/A 50 50	N/A 30 60	N/A 8 6	N/A 10 10	N/A 10 10	N/A 10 10
W48H1DB00, B0Z B06 B09	230/208-3	1 1 1	29 47 56	35 50 60	8 8 6	10 10 10	N/A N/A N/A	N/A N/A N/A	N/A N/A N/A	N/A N/A N/A	N/A N/A N/A	N/A N/A N/A	N/A N/A N/A	N/A N/A N/A
W48H1DC00, C0Z C09	460-3	1 1	14 27	20 30	12 10	12 10	N/A N/A	N/A N/A	N/A N/A	N/A N/A	N/A N/A	N/A N/A	N/A N/A	N/A N/A
W60H1DA00, A0Z A05 A10	230/208-1	1 1 or 2 1 or 2	41 67 93	60 80 100	8 4 3	10 8 8	N/A 41 41	N/A 26 52	N/A 60 60	N/A 60 60	N/A 8 8	N/A 10 6	N/A 10 10	N/A 10 10
W60H1DB00, B0Z B09	230/208-3	1 1	28 55	40 60	8 6	10 10	N/A N/A	N/A N/A	N/A N/A	N/A N/A	N/A N/A	N/A N/A	N/A N/A	N/A N/A
W60H1DC00, C0Z C09	460	1 1	15 28	20 30	12 10	12 10	N/A N/A	N/A N/A	N/A N/A	N/A N/A	N/A N/A	N/A N/A	N/A N/A	N/A N/A

① These "Minimum Circuit Ampacity" values are to be used for sizing the field power conductors. Refer to the National Electrical Code (latest version), Article 310 for power conductor sizing.  
**CAUTION:** When more than one field power circuit is run through one conduit, the conductors must be derated. Pay special attention to note 8 of Table 310 regarding Ampacity Adjustment Factors when more than three (3) conductors are in a raceway.  
 ② Maximum size of the time delay fuse or HACR type circuit breaker for protection of field wiring conductors.  
 ③ Based on 75°C copper wire. All wiring must conform to the National Electrical Code and all local codes.

## Indoor Blower Performance - CFM at 230 or 460 Volts

ESP in H <sub>2</sub> O	W18H1		W24H1	W30H1 W36H1		W42H1 W48H1		W60H1	
	High Speed Dry/Wet Coil	Low Speed Dry/Wet Coil	Single Speed Dry/Wet Coil	High Speed Dry/Wet Coil	Low Speed Dry/Wet Coil	High Speed Dry/Wet Coil	Low Speed Dry/Wet Coil	High Speed Dry/Wet Coil	Low Speed Dry/Wet Coil
0	1020/975	750/700	1020/975	1395/1315	950/935	1885/1800	1650/1600	2200/2000	1600/1450
.1	960/905	735/675	960/905	1340/1270	930/915	1770/1665	1550/1500	2100/1900	1525/1375
.2	865/800	710/650	865/800	1285/1190	910/885	1635/1550	1450/1400	2000/1800	1465/1200
.3	820/735	660/600	820/735	1205/1100	855/830	1500/1400	1350/1300	1875/1700	-/-
.4	735/650	605/550	735/650	1110/1000	800/755	1370/1285	1300/1175	1775/1600	-/-
.5	615/535	540/490	615/535	1005/870	-/-	1250/1150	-/-	1650/1475	-/-

Above data is with 1" standard throwaway filter and 1" washable filter.

For optional 2" pleated filter - reduce ESP by .15 in.

See installation instructions for maximum ESP information on various KW applications.

Speeds marked "bold" above are **Factory Connected**.

## Electric Heat Table----Refer to Electrical Specifications for Availability by Unit Model

Nominal KW	At 240V (1)				At 208V (1)				At 480V (2)			At 460V (2)		
	KW	1-Ph Amps	3-Ph Amps	Btuh	KW	1-Ph Amps	3-Ph Amps	Btuh	KW	3-Ph Amps	Btuh	KW	3-Ph Amps	Btuh
4.0	4.0	16.7		13,652	3.00	14.4		10,239						
5.0	5.0	20.8		17,065	3.75	18.0		12,799						
6.0	6.0		14.4	20,478	4.50		12.5	15,359	6.0	7.2	20,478	5.52	6.9	18,840
8.0	8.0	33.3		27,304	6.00	28.8		20,478						
9.0	9.0		21.7	30,717	6.75		18.7	23,038	9.0	10.8	30,717	8.28	10.4	28,260
10.0	10.0	41.7		34,130	7.50	36.1		25,598						
15.0	15.0	62.5	36.1	51,195	11.25	54.1	31.2	38,396	15.0	18.0	51,195	13.80	17.3	47,099
18.0	18.0		43.3	61,434	13.50		37.5	46,076	18.0	21.7	61,434	16.56	20.8	56,519
20.0	20.0	83.3		68,260	15.00	72.1		51,195						

(1) These electric heaters are available in 230/208V units only.

(2) These electric heaters are available in 480V units only.

## Heater Packages - Field Installed

• Designed for adding Electric Heat to 0 KW Units

• Circuit Breaker Standard on 230/208V Models

• ETL US & Canada Listed

• Toggle Disconnect Standard on 460V Models

Heat Pump Models	-A00 Models 230/208-1		-B00 Models 230/208-3		-C00 Models 460-3	
	Heater Model #	KW	Heater Model #	KW	Heater Model #	KW
W18H1	EHWH02A-A04 EHWH02A-A08	4 8	N/A		N/A	
W24H1	EHWH24H-A04 EHWH24H-A08	4 8	EHWH24H-B06	6	EHWH24B-C06	6
W30H1	EHWH30-A05 EHWH30-A10	5 10	EHWH03-B06 EHWH03-B09	6 9	EHWC03A-C06 EHWC03A-C09 EHWH03A-C15 *	6 9 15
W36H1	EHWH36-A05 EHWH36-A10 EHWH36-A15 *	5 10 15	EHWH36H-B06 EHWH03-B09 EHWH36H-B15 *	6 9 15	EHWC03A-C06 EHWC03A-C09 EHWH03A-C15 *	6 9 15
W42H1	EHWH42-A05 EHWH42-A10 EHWH42-A15 *	5 10 15	EHWH05-B06 EHWH05-B09 EHWH05-B15 *	6 9 15	EHWH42-C06 EHWH05A-C09 EHWH05A-C15 *	6 9 15
W48H1	EHWH04-A04 EHWH42-A05 EHWH42-A10 EHWH42-A15 * EHWH04-A20 *	4 5 10 15 20	EHWH05-B06 EHWH05-B09 EHWH05-B15 * EHWH05H-B18 *	6 9 15 18	EHWH05A-C09 EHWH05A-C15 *	9 15
W60H1	EHWH04-A05 EHWH04-A10 EHWH04-A15 * EHWH04-A20 *	5 10 15 20	EHWH05-B09 EHWH05-B15 * EHWH04-B18 *	9 15 18	EHWH05A-C09 EHWH05A-C15 *	9 15

**NOTE:** Field installed heater packages are not approved for use with top supply opening models.

\* Not available for dehumidification models.

Form No. S3398-410

Supersedes S3398-210

Page 12 of 16

## Cooling Application Data - Outdoor Temperature °F ①

Model	D.B./W.B. ②	Cooling Capacity	75°F	80°F	85°F	90°F	95°F	100°F	105°F	110°F	115°F	120°F
W18H1	75/	Total Cooling	17,900	17,000	16,200	15,300	14,300	13,500	12,600	11,700	10,800	9,900
	62	Sensible Cooling	14,300	13,900	13,600	13,200	12,800	12,400	12,000	11,600	10,800	9,900
	80/	Total Cooling	19,100	18,500	17,900	17,200	16,400	15,700	14,800	13,900	13,000	12,000
	67	Sensible Cooling	13,800	13,600	13,400	13,200	12,900	12,600	12,300	11,900	11,600	11,200
W24H1	85/	Total Cooling	22,800	21,700	20,600	19,500	18,300	17,200	16,000	14,800	13,700	12,500
	72	Sensible Cooling	14,200	13,800	13,500	13,100	12,700	12,200	11,800	11,200	10,700	10,200
	75/	Total Cooling	27,100	25,100	23,400	21,800	20,400	19,300	18,300	17,400	16,700	16,000
	62	Sensible Cooling	20,700	19,800	19,000	18,300	17,700	17,100	16,600	16,100	15,700	15,300
W30H1	80/	Total Cooling	28,900	27,300	25,900	24,600	23,400	22,400	21,500	20,700	20,000	19,400
	67	Sensible Cooling	20,000	19,400	18,800	18,300	17,800	17,400	17,000	16,600	16,300	16,000
	85/	Total Cooling	34,500	31,900	29,800	27,800	26,000	24,500	23,200	22,100	21,000	20,200
	72	Sensible Cooling	20,500	19,700	18,900	18,200	17,500	16,900	16,200	15,600	15,000	14,500
W36H1	75/	Total Cooling	31,900	30,300	28,800	27,400	26,000	24,700	23,400	22,200	21,000	19,800
	62	Sensible Cooling	24,800	24,200	23,700	23,000	22,400	21,700	21,200	20,400	19,800	19,100
	80/	Total Cooling	34,000	33,000	32,000	30,900	29,800	28,700	27,600	26,400	25,200	24,000
	67	Sensible Cooling	24,000	23,700	23,400	23,000	22,600	22,100	21,700	21,100	20,600	20,000
W42H1	85/	Total Cooling	40,500	38,600	36,800	34,900	33,100	31,400	29,800	28,100	26,500	25,000
	72	Sensible Cooling	24,600	24,100	23,500	22,900	22,200	21,400	20,700	19,800	19,000	18,100
	75/	Total Cooling	35,800	34,400	33,000	31,600	30,200	28,900	27,500	26,100	24,800	23,500
	62	Sensible Cooling	28,600	28,000	27,300	26,600	25,900	25,200	24,500	23,800	23,100	22,400
W48H1	80/	Total Cooling	38,200	37,500	36,600	35,700	34,600	33,600	32,400	31,100	29,800	28,400
	67	Sensible Cooling	27,700	27,400	27,000	26,600	26,100	25,600	25,100	24,600	24,000	23,400
	85/	Total Cooling	45,500	43,900	42,100	40,300	38,500	36,800	35,000	33,100	31,300	29,500
	72	Sensible Cooling	28,400	27,800	27,200	26,400	25,600	24,800	23,900	23,100	22,100	21,200
W60H1	75/	Total Cooling	46,500	43,600	41,000	38,700	36,600	34,900	33,200	32,000	30,800	29,900
	62	Sensible Cooling	36,200	35,100	34,000	33,200	32,400	31,700	31,100	30,600	30,200	29,900
	80/	Total Cooling	49,600	47,500	45,500	43,700	42,000	40,600	39,200	38,100	37,100	36,200
	67	Sensible Cooling	35,100	34,400	33,700	33,200	32,700	32,200	31,900	31,600	31,400	31,300
W72H1	85/	Total Cooling	59,100	55,600	52,300	49,400	46,700	44,400	42,300	40,600	39,000	37,600
	72	Sensible Cooling	36,000	34,900	33,900	33,000	32,100	31,200	30,400	29,600	28,900	28,300
	75/	Total Cooling	49,200	46,800	44,500	42,300	40,100	38,000	36,000	34,000	32,100	30,200
	62	Sensible Cooling	39,100	38,200	37,200	36,200	35,300	34,300	33,400	32,500	31,700	30,200
W84H1	80/	Total Cooling	52,500	51,000	49,400	47,800	46,000	44,300	42,400	40,500	38,600	36,600
	67	Sensible Cooling	37,900	37,400	36,800	36,200	35,600	34,900	34,300	33,600	33,000	32,300
	85/	Total Cooling	62,600	59,600	56,700	54,000	51,100	48,500	45,700	43,100	40,600	38,000
	72	Sensible Cooling	38,800	38,000	37,000	36,000	34,900	33,800	32,700	31,500	30,400	29,200
W96H1	75/	Total Cooling	56,800	54,300	52,000	49,600	47,000	44,600	42,100	39,700	37,100	34,500
	62	Sensible Cooling	43,800	42,700	41,600	40,400	39,300	38,100	37,000	35,800	34,700	33,400
	80/	Total Cooling	60,600	59,200	57,700	56,000	54,000	52,000	49,700	47,300	44,600	41,800
	67	Sensible Cooling	42,500	41,800	41,200	40,400	39,600	38,800	37,900	37,000	36,100	35,000
W108H1	85/	Total Cooling	72,200	69,200	66,300	63,200	60,000	56,900	53,600	50,300	46,900	43,400
	72	Sensible Cooling	43,500	42,400	41,400	40,100	38,900	37,600	36,100	34,700	33,300	31,600

① Below 65°F, unit requires a factory or field installed low ambient control.

② Return air temperature °F.

Capacity Multiplier Factors			
% of Rated Airflow	-10	Rated	+10
Total BTUH	0.975	1.0	1.02
Sensible BTUH	0.950	1.0	1.05

## Heating Application Rating and Outdoor Temperature °F \*

Model		0°	5°	10°	15°	20°	25°	30°	35°	40°	45°	50°	55°	60°	65°
W18H1	BTUH	4,700	6,000	7,300	8,500	9,500	10,200	11,000	11,700	13,800	15,800	17,400	18,700	19,900	21,200
	WATTS	1,480	1,500	1,520	1,540	1,540	1,540	1,540	1,540	1,590	1,630	1,660	1,680	1,700	1,720
	COP	0.94	1.18	1.41	1.62	1.81	1.95	2.10	2.23	2.55	2.85	3.08	3.27	3.43	3.62
W24H1	BTUH	8,400	10,000	11,700	13,400	14,300	14,700	15,100	15,500	19,100	22,600	25,000	26,700	28,400	30,000
	WATTS	2,040	2,080	2,110	2,150	2,170	2,170	2,170	2,170	2,270	2,360	2,420	2,460	2,500	2,540
	COP	1.21	1.41	1.63	1.83	1.94	1.99	2.04	2.10	2.47	2.81	3.03	3.19	3.33	3.47
W30H1	BTUH	10,200	12,200	14,200	16,200	17,700	18,800	19,900	21,000	24,400	27,700	30,200	32,200	34,200	36,200
	WATTS	2,460	2,500	2,540	2,580	2,600	2,600	2,590	2,590	2,700	2,800	2,860	2,900	2,940	2,980
	COP	1.22	1.43	1.64	1.84	2.00	2.12	2.26	2.38	2.65	2.90	3.10	3.26	3.41	3.56
W36H1	BTUH	13,100	15,400	17,800	20,100	21,500	22,300	23,100	23,900	28,500	33,200	36,400	38,800	41,100	43,400
	WATTS	2,800	2,850	2,900	2,950	2,970	2,970	2,970	2,970	3,090	3,220	3,300	3,350	3,400	3,450
	COP	1.38	1.59	1.80	2.00	2.13	2.20	2.28	2.36	2.71	3.03	3.24	3.40	3.55	3.69
W42H1	BTUH	15,400	18,200	21,100	23,900	25,400	26,100	26,700	27,400	33,500	39,600	43,700	46,600	49,400	52,200
	WATTS	3,460	3,540	3,620	3,690	3,740	3,760	3,780	3,800	3,960	4,130	4,240	4,320	4,390	4,470
	COP	1.31	1.51	1.71	1.90	1.99	2.04	2.07	2.12	2.48	2.81	3.02	3.17	3.30	3.43
W48H1	BTUH	15,800	18,800	21,800	24,800	26,500	27,300	28,100	28,900	35,200	41,500	45,800	48,800	51,800	54,800
	WATTS	3,560	3,620	3,670	3,730	3,750	3,760	3,770	3,770	3,900	4,030	4,110	4,160	4,220	4,270
	COP	1.31	1.53	1.75	1.95	2.08	2.13	2.19	2.25	2.65	3.02	3.27	3.44	3.6	3.77
W60H1	BTUH	19,600	23,200	26,900	30,600	32,300	32,800	33,300	33,800	42,200	50,700	56,200	59,900	63,600	67,200
	WATTS	4,320	4,410	4,490	4,580	4,620	4,630	4,650	4,660	4,850	5,050	5,170	5,260	5,340	5,430
	COP	1.33	1.55	1.76	1.96	2.05	2.08	2.10	2.13	2.55	2.95	3.19	3.34	3.49	3.63

\*70°F DB indoor return air at rated CFM includes defrost operation below 45°.

**NOTES**

## Heat Pump Wall-Mount Model Nomenclature

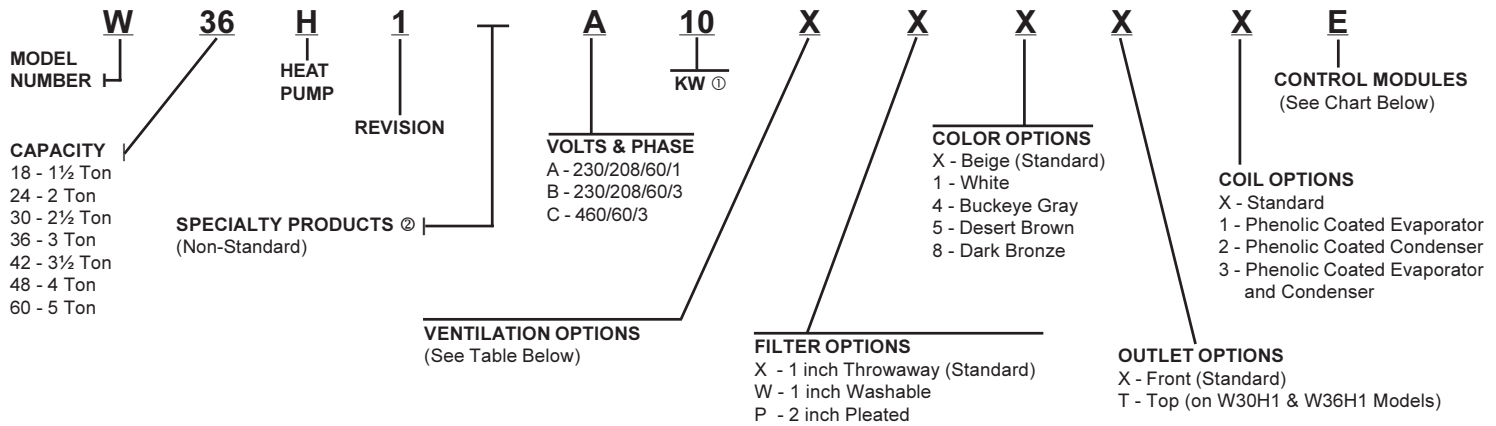

① For 0KW and circuit breakers (230/208 volt) or toggle disconnects (460 volt) applications, insert 0Z in the KW field of the model number.

② Insert "D" for dehumidification with hot gas reheat. Not available for Model W18H. Reference Form 7960-576 for complete details.

## Ventilation Options

MODELS	W18H1, W24H1		W30H1, W36H1		W42H1, W48H1, W60H1	
	Factory Installed Code No.	Field Installed Part No.	Factory Installed Code No.	Field Installed Part No.	Factory Installed Code No.	Field Installed Part No.
Barometric Fresh Air Damper - Standard	X	BFAD-2	X	BFAD-3	X	BFAD-5
Blank-Off Plate	B	BOP-2	B	BOP-3	B	BOP-5
Motorized Fresh Air Damper	M	MFAD-2	M	MFAD-3	M	MFAD-5
Commercial Ventilator - Spring Return w/Exhaust	V	CRV-2	V	CRVS-3	V	CRVS-5
Commercial Ventilator - Power Return w/Exhaust	---	---	P	CRVP-3	P	CRVP-5
Economizer (Internal) - Fully Modulating	E	EIFM-2B	E	EIFM-3C	E	EIFM-5C
Energy Recovery Ventilator - 230 Volt	R	ERVF-A2	R	ERVF-A3 ①	R	ERVF-A5 ①
Energy Recovery Ventilator - 460 Volt	R	ERVF-C2	R	ERVF-C3 ①	R	ERVF-C5 ①
Door Kit for ERVF (Required)	N/A	WMDK2-*	N/A	WMDK3-*	N/A	WMDK5-*

① Intake and exhaust can be independently adjusted.

\* WMDK Door Kit must be ordered in addition to ERVF Assembly and color matched to unit ("X" = Beige; "4" = Buckeye Gray; "8" = Dark Bronze)

## Heat Pump Control Modules — All Models

Description						Factory Installed Code Number	Field Installed Part Number
Low Pressure Control ①	High Pressure Control ①	Low Ambient Control and Relay ②	Start Kit ③	Start Kit ④	Outdoor Thermostat ⑤		
STD	STD					X	N/A
STD	STD	●				E	CMH-19
STD	STD				●	Q	CMH-14A
STD	STD	●			●	R	---
STD	STD	●	●			S	---
STD	STD	●	●		●	T	---
STD	STD		●			Field Installed	CMC-15 ⑥
STD	STD			●		Field Installed	SK111

STD = Standard Equipment

① The high & low pressure controls are auto reset. Operating circuit includes a lockout feature and is resettable from the wall thermostat. All low pressure controls use a timed bypass circuit to prevent nuisance tripping during low temperature start-up.

② The low ambient control includes an 8201-008 (fan relay) and permits cooling operation down to 0°F.

③ PTCR start kit can be used with all -A single phase models. Increases starting torque 2-3x. Not used for -B or -C three phase models. Do not use if SK111 is used.

④ Start capacitor and potential relay start kit can be used with all -A single phase models. Increases starting torque 9x. Not used for -B or -C three phase models. Do not use if CMC-15 is used.

⑤ The outdoor thermostat is adjustable from 0°F to 50°F. It is suitable for use as a compressor cut-off thermostat.

**NOTE:** Standard heat pump control board has a 5-minute compressor anti-short cycle timer.



Bard Manufacturing Company, Inc.  
Bryan, Ohio 43506  
www.bardhvac.com

Due to our continuous product improvement policy, all specifications subject to change without notice.

Before purchasing this appliance, read important energy cost and efficiency information available from your retailer.

Form No.  
S3398  
April, 2010

Supersedes S3398-210